

**Garage Doors** MADE BY RYTERNA



## Content

|                      |    |
|----------------------|----|
| TL&R40   RIB         | 10 |
| TL&R40   MIDRIB      | 12 |
| TL&R40   FLUSH       | 14 |
| TL&R40   CASSETTE    | 16 |
| TL&R40   SLICK       | 18 |
| TL&R40   SLICK PLUS  | 20 |
| TL&R40   MICRORIB    | 22 |
| TL&R40   MACRORIB    | 24 |
| INSPIRATION          | 26 |
| SIDE DOORS           | 28 |
| TWO LEAF SWING DOORS | 29 |
| PASS DOORS           | 30 |
| DECOR APPLIQUES      | 31 |

|                                 |    |
|---------------------------------|----|
| STAINLESS STEEL WINDOWS         | 32 |
| ACRYLIC DOUBLE GLASS WINDOWS    | 32 |
| FULL VISION PANELS              | 33 |
| HARDWARE TYPE R40               | 34 |
| HARDWARE TYPE TL                | 38 |
| ACCESSORIES                     | 42 |
| THE SIDE SLIDING SECTIONAL DOOR | 44 |
| HARDWARE TYPE                   | 46 |



## Unlimited creativity

Freedom to express your ideas in many ways.





## Think outside the door

Diversity of modern designs, variety of colours, number of features. Whether to merge with the general architecture, or to create a landmark in the neighbourhood. Long-lasting solutions and no halfway towards the quality.





## Look and functionality

Strict lines and square shapes for minimalistic view. Or just a simplest solution to cover your garage space from the outside.





TL&R40 | Rib



## TL&R40 | RIB

Horizontal ribs every 10 cm gives this door lightweight look and extra sturdiness at the same time. This is a contemporary looking door that looks good fitted in any architectural setting.

Wood Rib comes in 4 different naturally looking wood images – golden oak, old oak, dark oak and mahogany.

Rib door is often combined with full-vision aluminum panels available in any door colour and also golden oak image.

Rib type door is the best in special cases of oversized openings – it can be made up to 10 meters wide.



Other painted colours similar to RAL palette.

### Panel styles:



RAL 9016  
(woodgrain)

RAL 9016  
(stucco)

### Wood images:



Golden Oak  
(woodgrain)

Old Oak  
(woodgrain)

Dark Oak  
(woodgrain)

Mahogany  
(woodgrain)



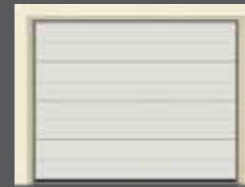

## TL&R40 | MIDRIB

The Midrib style door grooved in the middle of each panel, makes an impression of a solid wooden boards. This is quite a popular style all over Europe. Midrib panels available in woodgrain stucco and smooth patterns, white RAL 9016 or painted other RAL colours. The Wood Midrib style door comes with a smooth, non-embossed surface, coated with natural wood looking UV proof pvc tape. Golden, old and light oak images available.

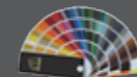

Other painted colours similar to RAL palette.

### Panel styles:



RAL 9016  
(woodgrain)

RAL 9016  
(stucco)

RAL 9016  
(smooth)

### Wood images:



Golden Oak  
(smooth)

Old Oak  
(smooth)

Light Oak  
(smooth)



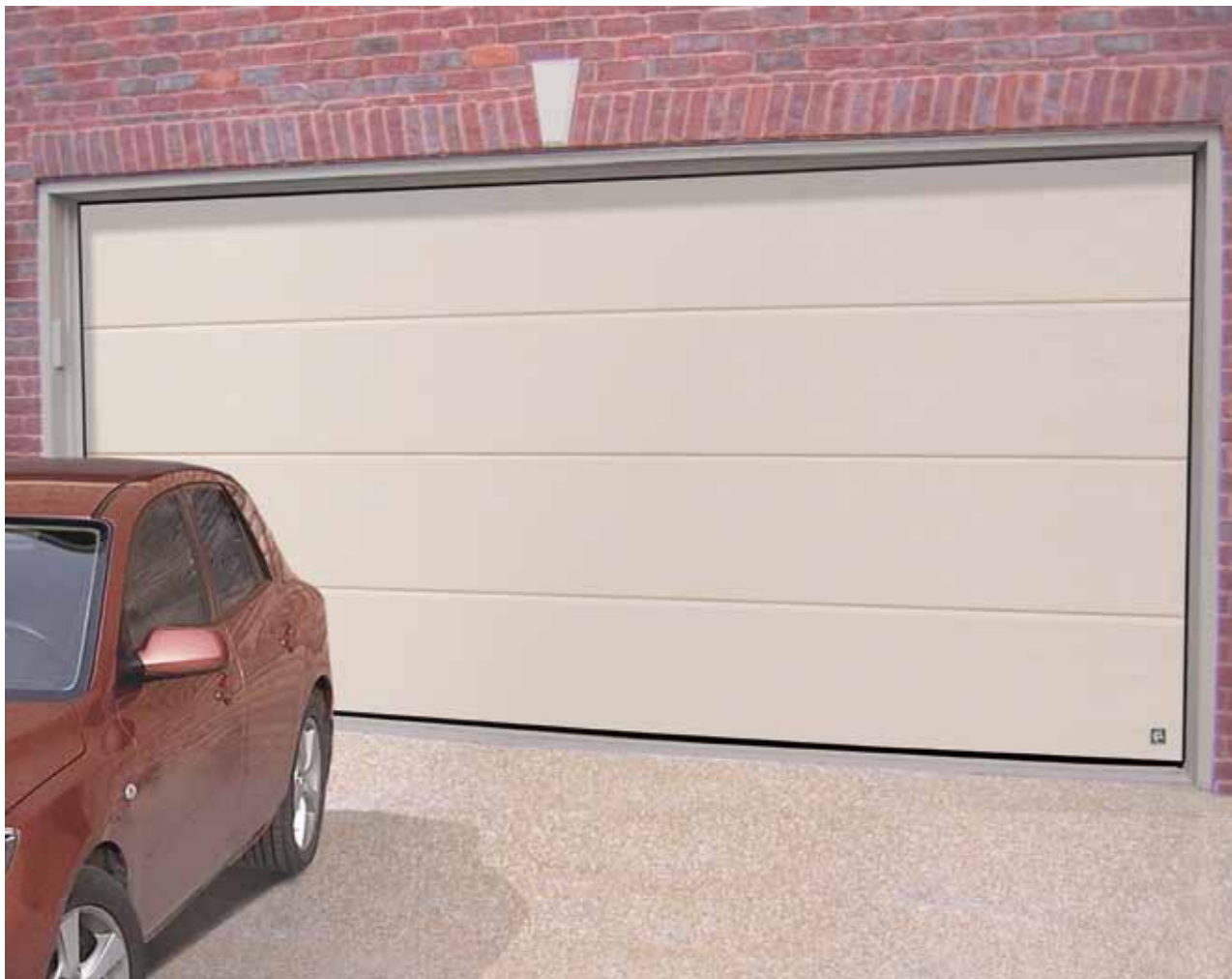

TL&R40 | Flush



## TL&R40 | FLUSH

The Flush door design with its flat panels, woodgrain or stucco embossed surface offers a look that complements both classic and modern homes. The look is subtle and understated but is impressive when decorated with stainless steel windows.

Flush type doors available in standard RAL 9016 white and RAL 7016 grey, or painted.

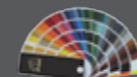

Other painted colours similar to RAL palette.

### Panel styles:



RAL 9016  
(woodgrain)



RAL 9016  
(stucco)







TL&R40 | Cassette

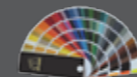

Other painted colours similar to RAL palette.

Panel style:



RAL 9016  
(woodgrain)

Wood image:



Golden Oak  
(woodgrain)

TL&R40 | CASSETTE

The Cassette door attracts with its stylish Georgian type rectangular cassettes beautifully sculptured with crisp lines and details on the outer surface. The cassette door is mainly suited to the traditional or country style of home. When there are any wooden elements used for decoration of the house, the Wood Cassette door, coated with naturally looking golden oak image tape, will look perfect.





TL&R40 | Slick

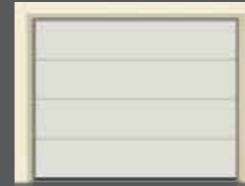

## TL&R40 | SLICK

The Top of the line Slick style door offers totally flat and smooth panel surface. Double outside steel thickness is used to give this door a really solid look and performance. Top aesthetic door fits great in any exclusive building. Smooth surface is great for decorating with stainless steel windows.



Other painted colours similar to RAL palette.

Panel style:



RAL 9016  
(smooth)



RAL 9006  
(smooth)



RAL 7016  
(smooth)





## TL&R40 | SLICK PLUS

Exclusively coated

Smooth doors got the name of "Slick Plus" for original idea and impressive look of Rusted image, Anthracite, Stainless image and Golden Oak. Impressive looking Slick-Plus coating - Rusted, Golden Oak image, Anthracite coated RAL 7016 surface and Stainless Steel.

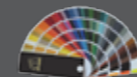

Other painted colours similar to RAL palette.

### Panel styles:



Golden Oak (smooth)



Anthracite (smooth)



Rusty (smooth)



Stainless Steel (smooth)



Golden Oak (smooth)



Anthracite (smooth)



Rusty (smooth)



Stainless Steel (smooth)





TL&R40 | Microrib

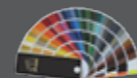
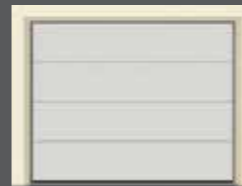

Other painted colours similar to RAL palette.

Panel style:



RAL 9016 (smooth)

## TL&R40 | MICRORIB

The Microrib. The strength of this modern style door lies in its exceptional smooth surface slightly waving every 5 mm. This unique panels design can be made creative when decorated with stainless steel windows.

Microrib doors come in standard RAL 9016white or painted in other RAL colours.





## TL&R40 | MACRORIB

The surface of macrorib door is stucco embossed and formed in soft waves, every 10 mm. Nice looking modern style door, suitable for both residential and commercial architecture.

Macrorib door comes in standard RAL 9007 or painted in other RAL colours.

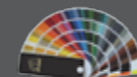

Other painted colours similar to RAL palette.

Panel style:



RAL 9007  
(stucco)





Inspiration



### REALIZING YOUR IDEAS:

Lots of custom made doors were produced to meet needs of our customers. Different panel combinations, painted windows, special design of Full-Vision panels and many other solutions may be brought into life to match the style, customer requires.

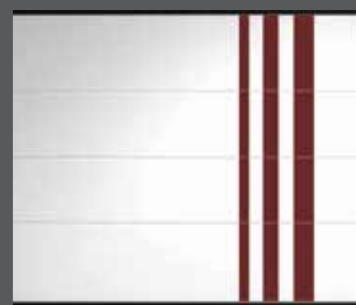

Door frame can be ordered with or without edging



Without edging



With edging



Easy fitting to side walls



Ryterna side doors are eqript with sliding door closers

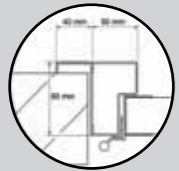

Frame domentions



Handls standart colours: silver, black, white. Other colours upon request.



## SIDE DOORS

Ryterna manufacture tailor made side doors to match the garage door you choose. Ryterna side doors are made of PU insulated 40 mm thick. Sectional door panels surrounded with aliuminium profiles, and all-round rubber seals. Side door panels windows are aligned with sectional door panels or windows.

Double leaf entry doors available on request.

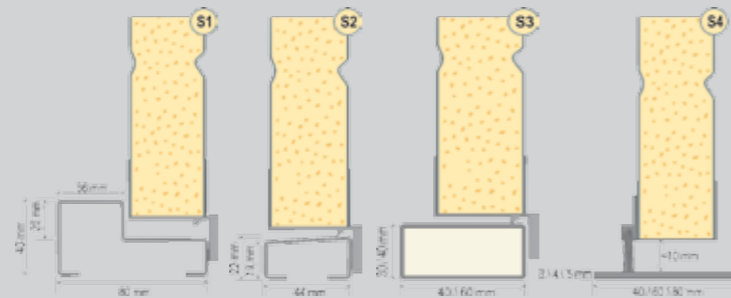

Side Doors | Two leaf swing doors



## TWO LEAF SWING DOORS

Two leaf doors are recommended when the opening is wider than 1300 mm.

When used as garage door, S4 lowstep profile (see page 28) is recommended.





## PASS DOORS

When additional entry is required and there is no space for the side door, the wicket door into the garage door could be an option. Wicket doors are supplied as standard with a door closer, lock and handle. You can choose the standard pass door or a new version with a low step, which is more convenient to get your bicycle or barrow through the pass door.

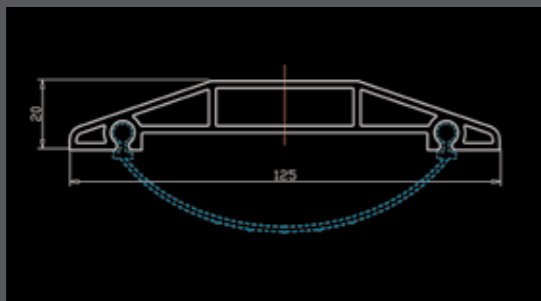

## Pass Doors | Decor Appliques



## DECOR APPLIQUES

Whilst a wide range of decors offered by Ryterna, we welcome your personal artistic design to make your garage door an object of your own creativity. Forward your design and we will apply them to the garage door when possible. You can create the design to match you standard entrance door or similar. All we require are the measurements of the door you wish to match the design to and a picture of the existing door to copy the design.

Appliques are made in stainless steel and RAL coloured plate.

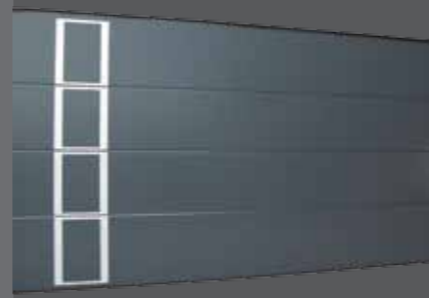





## STAINLESS STEEL WINDOWS

Using windows from our stainless design range will make the door look modern and unique. Use our recommended designs or create your own.



MAXI 315 x 315 mm  
MIDI 235 x 235 mm  
MINI 155 x 155 mm  
805 x 155 mm

MAXI Ø 315 mm  
MIDI Ø 235 mm  
MINI Ø 155 mm

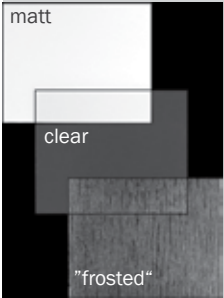

## ACRYLIC DOUBLE GLASS WINDOWS

A range of windows and decorative inserts are offered to add distinction to any home. Acrylic window frames and inserts can be painted to match your door colour or existing trim colours on your house.

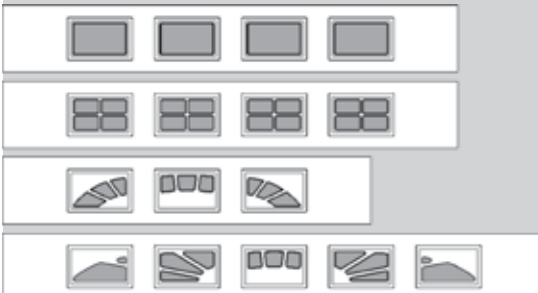

## FULL VISION PANELS

Full vision panels can be provided in anodized aluminum frame, painted door colour or in golden oak effect coating.



## HARDWARE TYPE R40

R40 sectional garage door have been designed to be a consumer and installer friendly door – with its minimized head-room and side-room being ideal for as for new houses, as well for replacing old garage doors. Made to size and factory pre-assembled R40 door is very easy and fast to install.

Safe and reliable track system. All Cable pulleys covered to protect from the possibility of injury.

Rubber weather seals at the sides will ensure the door is properly closed from the bottom to the top. It also serves as a finger protection.

Bottom seal works as a minor shock-absorber and eliminates floor irregularities tightly closing the garage door.

Tension springs assembly. Side mounted or under-track mounted springs are factory pre-installed and covered, what grants an easy installation and safe operation. Four spring system protects the door even in case of one spring failure.

Ball bearing rollers. Nylon coated rollers guarantee longer service and quite operation.

Finger protection. Anti-pinching panels prevents the possibility of injury while operating the door.

Side hinge with adjustable roller carrier ensures most efficient roller performance and keeps it from derail.

Convenient handle comes at the bottom corner bracket that would be very useful in case of power failure.

## HARDWARE TYPE R40

### Longer durability

R40 track system comes fully preassembled with tension springs, cables and accessories. The door with R40 type hardware is very easy and fast to install. Maximal R40 door measurements 3000 x 2500 mm.

### Technical specifications in accordance to EN 13241-1

### Safety features in accordance to EN 13241

Tension spring  
Ball bearing rollers  
Safe track system  
Reinforced frame with side finger protection  
Doors are tested to meet CE norm 89/107/EC  
Anti-pinching panels from the inside and outside.  
Insulation infill – CFC free PU foam.

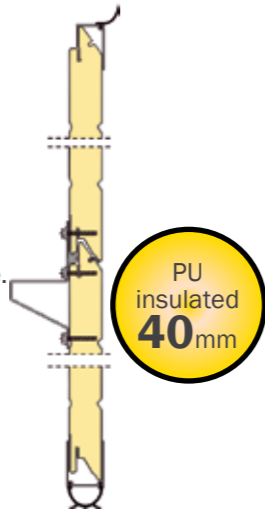

R40 | SM

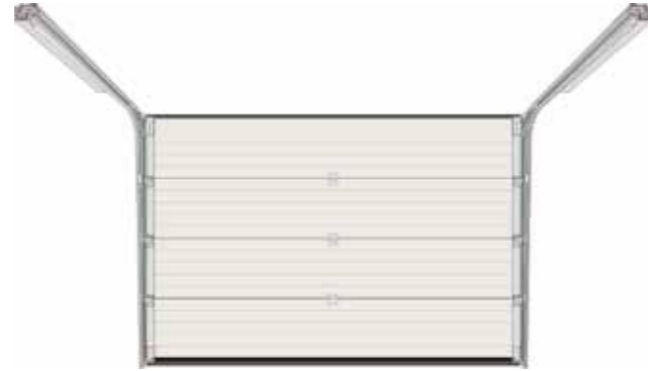

R40 | UM



R40 | SM

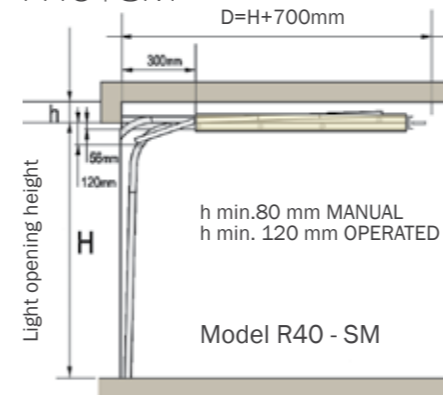

R40 | UM

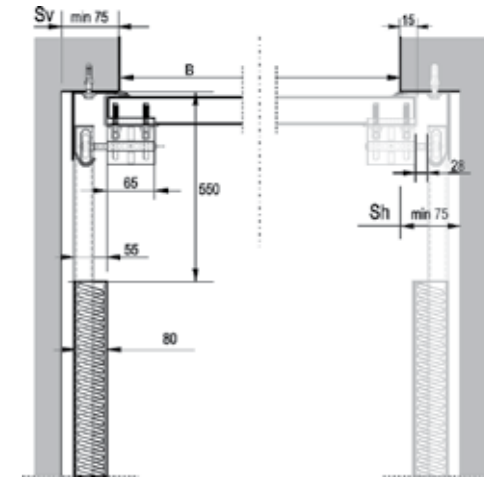
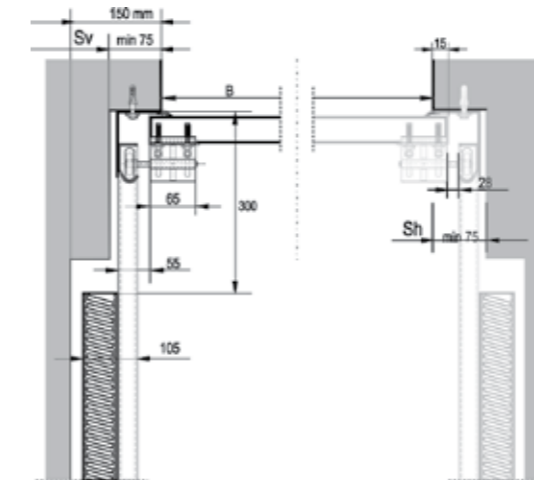
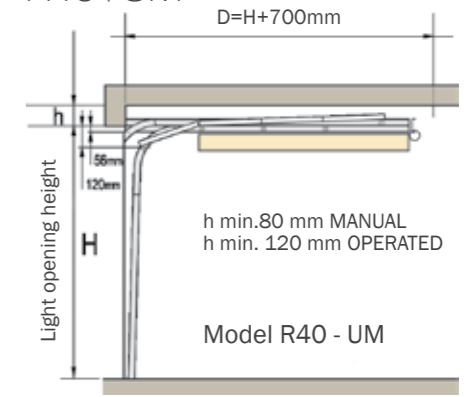

## HARDWARE TYPE TL

Many components of our sectional garage door have been developed and tested under much demanding industrial conditions. Over decades of operations we've perfected every detail of our door. Today we call it Intelligent Quality and it is a continuous process.

Safe and reliable track system. Industrial grade track is designed for reliable and secure operation.

Rubber weather seals at the sides will ensure the door is properly closed from the bottom to the top. It also serves as a finger protection.

Bottom seal works as a minor shock-absorber and eliminates floor irregularities tightly closing the garage door.

Torsion springs. Every garage door comes with spring break protection mechanism for the each spring in the system.

Ball bearing rollers. Nylon coated rollers guarantee longer service and quite operation.

Finger protection. Anti-pinching panels keep your finger safe.

Side hinge with adjustable roller carrier ensures most efficient roller performance and keeps it from derail.

Convenient handle comes at the bottom corner bracket that would be very useful in case of power failure.

## HARDWARE TYPE TL

### Longer durability

TL track system with torsion springs provides perfect counterbalance for a sectional door of any size or width. For challenging installation conditions we have developed LHR-FM and LHR-RM hardware types.

### Technical specifications in accordance to EN 13241-1

### Safety features in accordance to EN 13241

- Industrial grade torsion springs
- Ball bearing rollers
- Safe track system
- Reinforced frame with side finger protection
- Doors are tested to meet CE norm 89/107/EC
- Anti-pinching panels from the inside and outside.
- Insulation infill - CFC free PU foam.

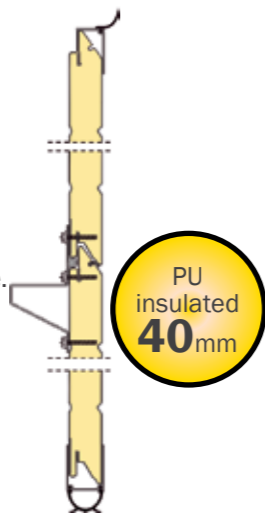

TL | LHR-FM with torsion springs

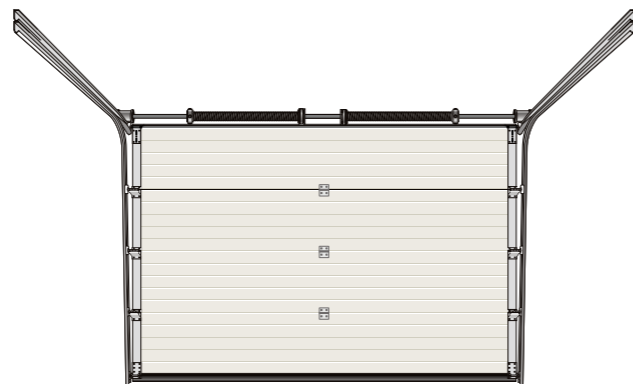

TL | LHR-RM with torsion springs

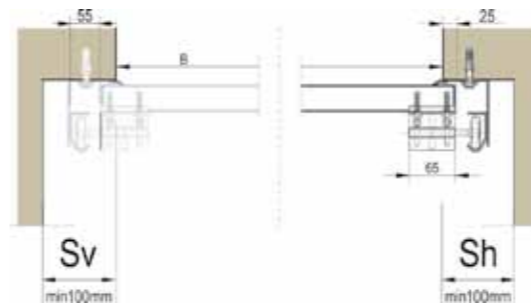
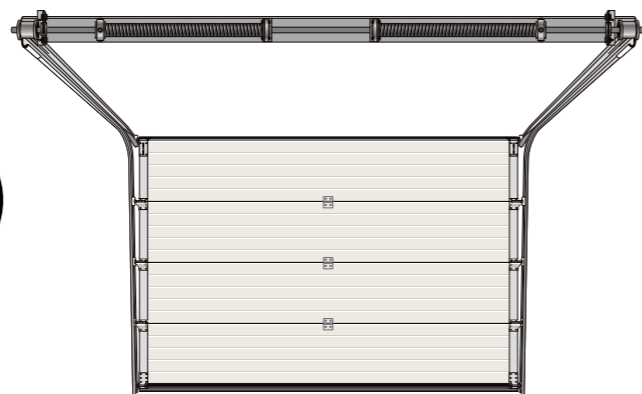

LHR FM low headroom lift double tracks, front mounted springs

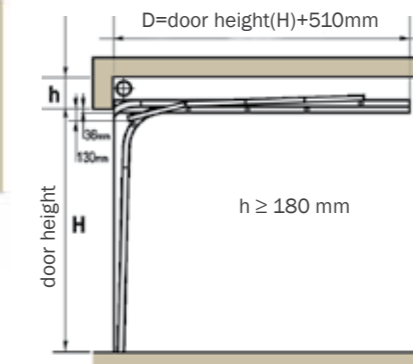

LHR RM low headroom lift double tracks, rear mounted springs

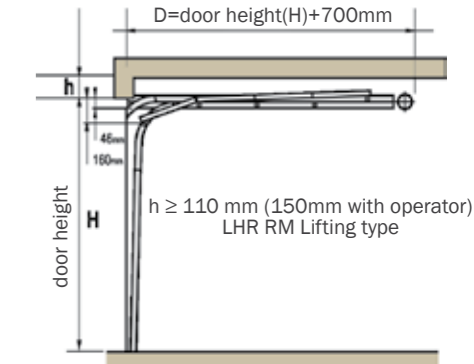

STD



HL

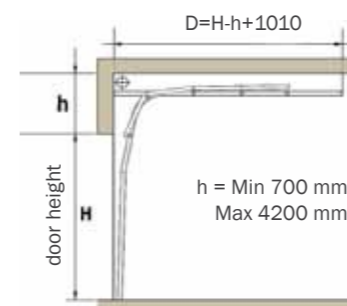

VL

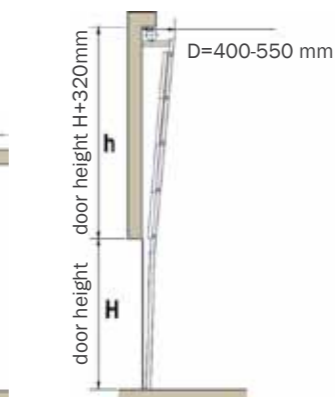

ROOFPICH

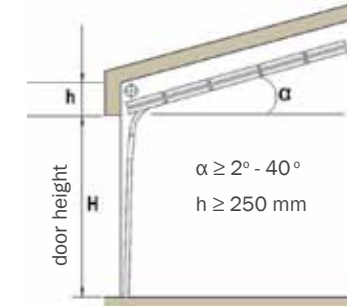



◀ Telaio montaggio in luce con veletta da 120 mm (per porte R40 e LHR RM) con veletta da 180 mm (per porte LHR FM) spallette da 100 mm



▶ Reinforced lintel profile for fitting to the ceiling.

▶ Veletta in alluminio 120 mm; 180 mm.



▶ Lintel profile with weatherseal (standard at R40 doors) 120 x 40 mm. Standard black, also available in door colour and structure.



◀ Decorative angle 100 x 40 mm. Available in woodgrain golden oak and woodgrain white.



Accessories



◀ White door leaf parts (hinges, top and bottom brackets) and even all track system coated in white, is available as an option.



UNIVERSAL LOCK



KNOB LOCK



UNIVERSAL HANDLE



KNOB HANDLE

◀ Most of doors are electrically operated, but for those that are will be used manually Ryterna offers own design locks and handles.



The Side Sliding Sectional Door

## THE SIDE SLIDING SECTIONAL DOOR

- ▣ The door designed for elegant look, convenient use, a long-life functioning.
- ▣ Variety of panel designs – smooth, ribbed or embossed.
- ▣ Door can be partially opened – for pass door use, or just a half door opening. Convenient and thermally efficient.
- ▣ Corrosion-resistant and low-maintenance aluminum hardware, top quality carriages and no-spring system provides quiet and trouble free operation.
- ▣ 40 mm PU panels and brush seals along perimeter provides high thermal insulation.
- ▣ Low ground rail with no requirement for built in floor channel.

### Types of door sections:



### Standard colour:

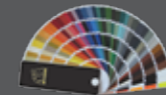

Other painted colours similar to RAL palette.

### Panel styles:



**HARDWARETYPE**  
**The Side Sliding Sectional Door**



Optional electric operator for Your additional convenience.

Optional special lock for a manually operated sliding door.

Brush seals along all perimeter.

Ball bearing rollers, heavy duty carriages and solid rails designed for a door up to even 30 square meters.

Low ground rail can be fixed on the existing floor – easy to fit and no maintenance required.





[www.ryterna.eu](http://www.ryterna.eu)

